



PII S0008-8846(97)00031-8

**PERMEABILITY STUDY OF CRACKED CONCRETE**

**Kejin Wang, Daniel C. Jansen, Surendra P. Shah**  
The NSF Center for Advanced Cement-Based Materials  
Northwestern University, 2145 Sheridan Rd., Evanston,  
Illinois 60208-4400, USA

**Alan F. Karr**  
National Institute of Statistical Sciences  
PO Box 14162, Research Triangle Park,  
North Carolina 27709-4162, USA

(Refereed)

(Received August 19, 1996; in final form January 27, 1997)

**ABSTRACT**

Cracks in concrete generally interconnect flow paths and increase concrete permeability. The increase in concrete permeability due to the progression of cracks allows more water or aggressive chemical ions to penetrate into the concrete, facilitating deterioration. The present work studies the relationship between crack characteristics and concrete permeability. In this study, feedback controlled splitting tests are introduced to generate crack width-controlled concrete specimens. Sequential crack patterns with different crack widths are viewed under a microscope. The permeability of cracked concrete is evaluated by water permeability tests. The preliminary results indicate that crack openings generally accelerate water flow rate in concrete. When a specimen is loaded to have a crack opening displacement smaller than 50 microns prior to unloading, the crack opening has little effect on concrete permeability. When the crack opening displacement increases from 50 microns to about 200 microns, concrete permeability increases rapidly. After the crack opening displacement reaches 200 microns, the rate of water permeability increases steadily. The present research may provide insight into developing design criteria for a durable concrete and in predicting service life of a concrete structure. © 1997 Elsevier Science Ltd

**Introduction**

Concrete deterioration is related to its permeability. Most researchers believe that a well designed and manufactured concrete is originally water-tight, containing discontinuous pores and microcracks. When subjected to extreme loading or weathering, concrete deteriorates through a variety of physical and chemical processes, which result in cracking. Cracks in concrete generally interconnect flow paths and increase concrete permeability. The increase in concrete permeability due to crack progression allows more water or aggressive chemical

ions to penetrate into the concrete, facilitating further deterioration. Such a chain reaction of “deterioration—cracking—more permeable concrete—further deterioration” may eventually result in destructive deterioration of the concrete structure (1). Therefore, it is significant to understand the mutual interaction and relationship between concrete cracks and its permeability.

Due to difficulties in generating desirable crack patterns in concrete specimens and availability of appropriate methods for concrete permeability measurements, a limited number of studies have been done on the permeability of cracked concrete. Some related research has been conducted on measuring permeability of concrete subjected to compressive loading. It was reported that the application of compressive loads had little effect on both chloride and water permeability of concrete although some evidence indicates that significant microcracking occurred in the concrete (2, 3). These results seem to contradict the widely accepted holistic model that shows the chain reaction of concrete deterioration above (1). Since crack characteristics were not studied in the previous research, it is not clear whether the results are related to the loading methods or to the permeability measurements. It is possible that crack openings generated under loading may recover significantly after unloading; thus resulting in an insignificant increase in connected flow paths in concrete. For the concrete having excessively wide and connected cracks, it is not clear whether the rapid chloride permeability test is still suitable for permeability measurement because the specimen may heat up quickly and the sodium chloride and sodium hydroxide solutions used in the test may mix through the cracks. It seems desirable to study permeability of cracked concrete by generating cracks in tension and taking water permeability measurements.

Tsukamoto (4) measured the rate of water flows in plain and fiber reinforced concrete specimens under uniaxial tension. In this study, slab-shaped specimens were used for the uniaxial tensile loading, and notches were made on the sides of the specimens for producing cracks in the middle of the specimens. Due to the shape of the specimens, one-directional water flow was not achieved, and calculation of the concrete permeability coefficient became complicated. A more appropriate testing method is needed to study permeability of cracked concrete.

In the present research, feedback controlled splitting tests are introduced to generate width-controlled cracks in concrete specimens. This testing method has several advantages: (1) cracks are produced by tensile stresses, (2) crack opening displacement is recorded during loading and after unloading, and (3) the cylindrical specimens used in the loading tests are preferable for conventional concrete permeability tests. After the splitting tests, sequential crack patterns were viewed under an optical microscope. Water permeability of the cracked concrete specimens was evaluated. Studying the relationship between crack characteristics and concrete permeability, the present research provides insight into developing design criteria for a durable concrete, predicting service life of a concrete structure, and determining repair strategies and methods for deteriorated concrete.

### **Experimental Program**

Concrete specimens used in the present study were 25 mm (1 in.) thick slices, cut from 100mm × 200mm (4in × 8in) cylinders. By means of the feedback controlled splitting tests, the specimens were loaded to have a crack opening displacement of 25, 50, 80, 110, 140, 180, 350, or 550 microns, and then unloaded. After unloading, the crack patterns of some of

TABLE 1  
Mix Proportion of Concrete

Materials	Mix Proportion	
	(kg/m <sup>3</sup> )	(lb/yd <sup>3</sup> )
Cement (Type I)	344	579
Water	195	328
Pea Gravel (oven dry) (MSA=9 mm or 3/8")	1036	1743
River Sand (oven dry) (F.M.=2.6)	858	1444

the specimens were examined under an optical microscope. Then, water permeability of the specimens was tested.

**Concrete Mix Proportion and Properties.** The concrete mix proportion used in the present study is given in Table 1. The water/cement ratio of the mix was 0.41 (by weight). The slump of the fresh concrete was 3.2 cm (1.25 in.). The specimens were cured under water, in a room with a temperature of 20°C, for about 90-100 days before being subjected to splitting tests and permeability tests. The 28-day compressive strength of the concrete was 45 MPa (6500 psi).

**Feedback Controlled Splitting Tests.** The feedback controlled splitting test is a Brazilian splitting test controlled by a closed-loop feedback system. Closed-loop test machines function by adjusting the actuator (loading ram) to get a desired value from a measured parameter or a feedback signal. This measured parameter could be force or stroke, although for these tests it was the average displacement measured by the lateral LVDTs. By continuously increasing the desired value, the value of the feedback measurement is also increased even if the load carrying capacity of the specimen decreases (6). The test setup is shown in Figure 1. A cylindrical specimen (100 mm in diameter and 25 mm in thickness) was loaded diametrically under Brazilian test configuration. A single LVDT was fixed on each side of the specimen, perpendicular to the loading direction, so as to monitor the crack opening displacement (COD). The LVDTs each had a range of  $\pm 0.5$  mm. Plywood strips, 25 mm wide and 3 mm in thickness, were placed between the loading plates and the specimen to prevent crushing at the loading points. The 4.4 MN test machine (one million pound) was used with a 490 kN strain gage load cell to measure the force (a calibrated range of 49 kN was used for the 25 mm thick specimens). The average displacement of the two LVDTs was digitally calculated and used as the feedback control. The control parameter, the average crack opening displacement, was increased at a constant rate of 0.2  $\mu\text{m}/\text{sec}$ . The specimens were loaded to a predetermined crack width under the feedback controlled condition; and then, unloaded under force control. The time, force, stroke, and crack opening displacement from each LVDT as well as their average (used as the feedback signal) were recorded during tests.

The test results were plotted by a curve of the average displacement of the two LVDTs as a function of tensile stress. The stress is defined as  $\sigma = 2P/\pi LD$ , where  $\sigma$  is the tensile stress perpendicular to the loading direction along the diameter from one load point to the other, P is the force applied to the specimen, L is the specimen length or thickness, and D is the specimen diameter.

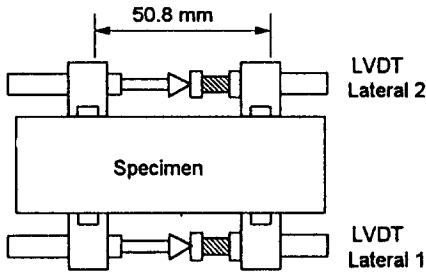
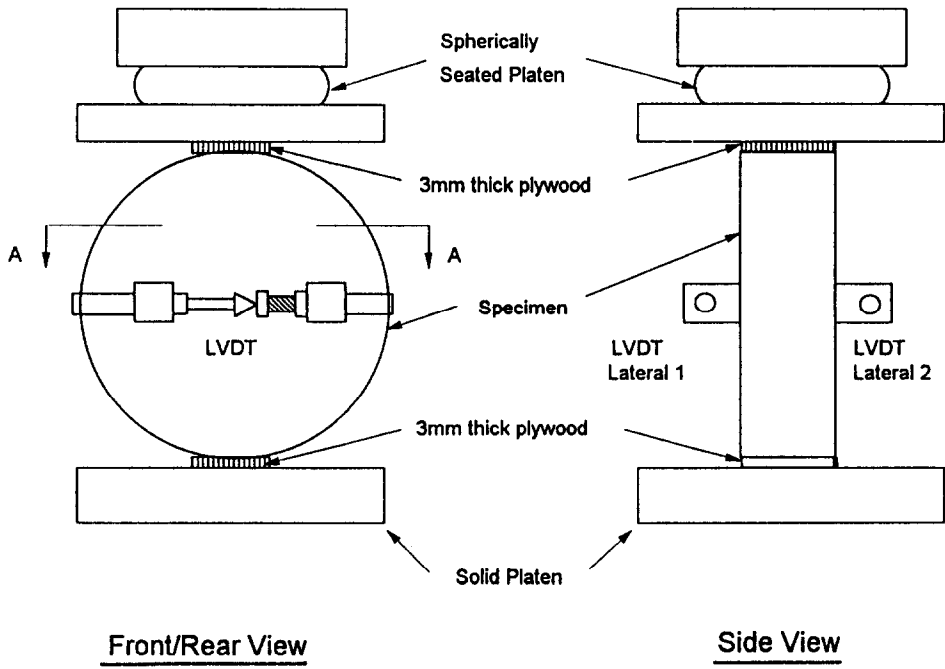

Specimen size:  
10 cm dia. X 2.5 cm high

Section A-A

FIG. 1.  
Feedback controlled splitting test setup.

**Permeability Tests.** Water permeability tests were performed on the cracked specimens. The testing procedure includes specimen vacuuming and saturation, test setup, and permeability measurement (3).

*Specimen vacuuming and saturation.* The vacuuming and saturation followed the sample preparation for rapid chloride permeability tests (AASHTO T277). The specimens were first vacuumed in a desiccator for 3 hours. De-aired water was added, and the specimens were vacuumed under water for another hour. The de-aired water was obtained from boiling de-ionized water for 2 hours and cooling to room temperature. After saturated vacuum, the specimens were left in the desiccator and soaked for at least 12 hours.

*Test setup.* After removal from the desiccator, the centers of both top and bottom surfaces of the specimen were covered with a disc of rubber, 75 mm (3 in.) in diameter and 1.6 mm (1/16 in.) thick. The rest of the specimen surface was dried with a paper towel and coated with fast-setting epoxy. The purpose of this procedure was to prevent moisture loss of the specimen during specimen preparation.

The specimen was then mounted and clamped as shown in Figure 2. Two plexiglas rings, 76 mm (3 in.) inside diameter, 5 mm (3/16 in.) thick, and 25 mm (1 in.) high, were mounted on the top and bottom surface of the specimen with silicon rubber. A 12 mm × 138 mm × 138 mm (0.5 in. × 5.5 in. × 5.5 in.) plexiglas plate with a pipette was mounted on the top plexiglas ring immediately after the rubber disc was removed, and another, with a drain tube, was placed on the bottom ring. Four threaded bars were used to clamp the cell together. The specimen circumferential surface and all connections were re-sealed with silicon rubber to ensure there would be no leaking of water. After the silicon rubber set, the cells were filled with de-ionized water both above and below the specimen.

*Permeability measurement.* The water permeability test started with the filling of the pipette with water. The water permeated from top to bottom due to the pressure head, which was about 300 mm (1 ft.) of water. The water drop was measured at regular time intervals, normally once a day, depending on the water flow rate of the specimen. After each measure-

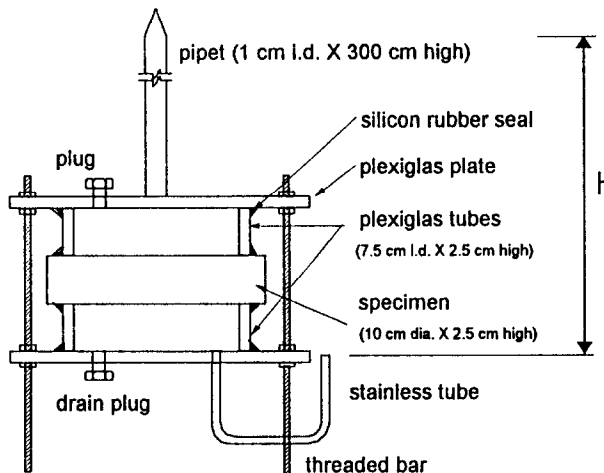

FIG. 2.  
Schematic view of water permeability apparatus.

ment, water was restored to the original level by refilling the pipette with a syringe from top. The test results were plotted with a curve of the cumulative water flow versus time. Previous studies have shown that after about 7 days, the curve becomes linear (3), which indicates that a steady state flow is established and Darcy's law can be applied to the permeability analysis. As a result, in the present study, most specimens were tested for 20 days and a few were tested for 50 days to ensure that steady state flow was achieved.

The coefficient of permeability ( $k$ , in cm/sec) based on Darcy's law for a falling water head can be calculated according to the following equations (5):

$$\frac{dQ}{dt} = -\frac{A' dh}{dt} = k \frac{h}{L} A \quad (a)$$

$$-\frac{dh}{h} = k \frac{hA}{A' L} dt \quad (b)$$

Integrating from  $h_0$  to  $h_1$ :

$$k = \frac{A' L}{At} \ln \frac{h_0}{h_1} \quad (c)$$

Here,  $A'$  is the cross sectional area of pipette ( $0.5 \text{ cm}^2$ );  $A$ , cross sectional area of specimen ( $\text{cm}^2$ );  $h_0$  and  $h_1$  are initial and final water heads (cm);  $L$  is the specimen thickness (cm);  $Q$  is the volume of water flow ( $\text{cm}^3$ ); and  $t$  is time (sec).

## Results and Discussion

**Feedback Controlled Splitting Tests.** The results from the feedback controlled splitting tests are shown in Figure 3. It was observed that the peak load generally occurred at an average transverse displacement of about 20 microns. The peak stress, or the tensile strength, was about 6 MPa. After passing the peak stress, the load was reduced due to the initiation of cracks in concrete.

The data from the two LVDTs showed that the cracks generally opened on one face first and on the other face later. This means that to guarantee a stable feedback control, it is essential to use a combination of the lateral displacements measured on both faces as the feedback signal. When the load dropped to about 75% of the peak load, it remained constant as the displacement increased, and a plateau appeared in the curve. At this stage, the measured displacement resulted primarily from the crack opening displacement. Note that the transverse displacement is not identical to the crack opening displacement until the stress reaches peak stress. For simplicity, however, the crack opening displacement in the present paper indicates the displacement between the two points where a LVDT amounted for all range of loading.

Once the measured displacement reached the predetermined cracked width, the specimen was unloaded. The slope of the curve during unloading was less steep than that during loading, which indicates the stiffness of the concrete was reduced due to the cracking. The degree of the stiffness reduction of concrete depended on the maximum crack opening

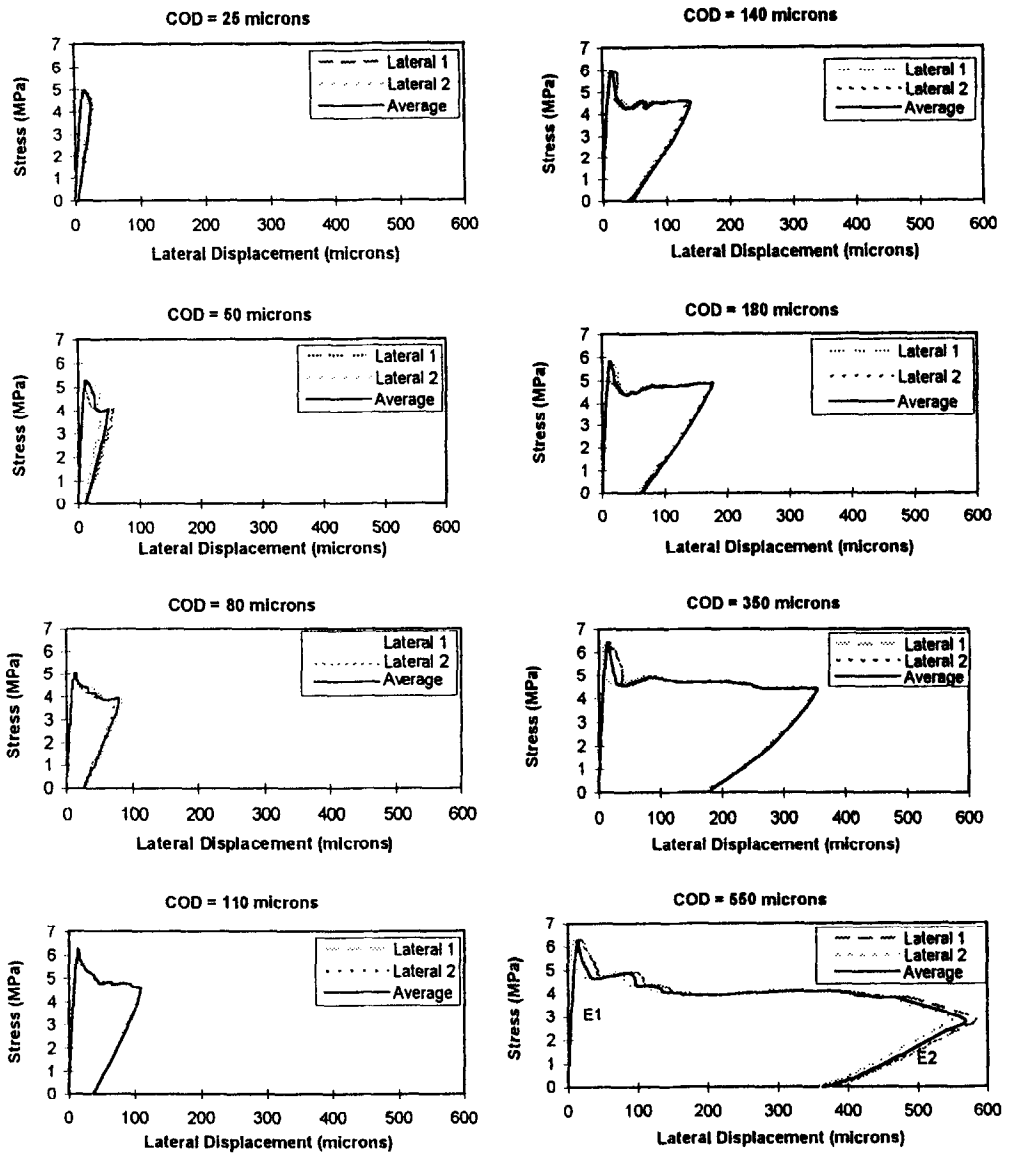

FIG. 3. Results from feedback controlled splitting tests.

displacement of the specimen (Figure 4). Here, stiffness of cracked concrete was defined as the slope of a line connecting two points with the stresses of 1 MPa and 3 MPa in the unloading curve. It was also noticed that after complete unloading, the crack opening displacement was reduced, i.e., the crack partially closed or recovered due to the material elasticity. The relationship between the crack recovery and the maximum crack opening displacement is shown in Figure 5. If a specimen was unloaded before reaching or even at the peak load, about 80% of the displacement could be recovered, and the remaining crack

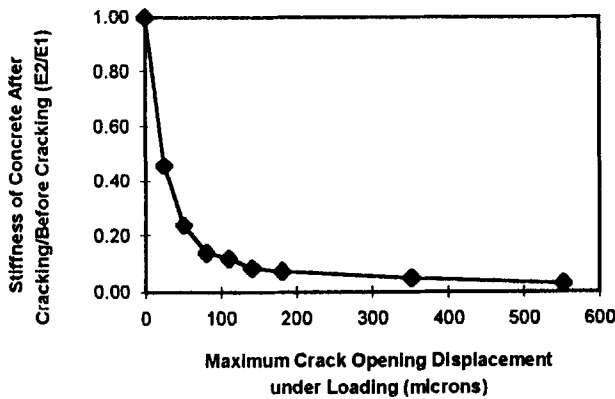

FIG. 4. Stiffness reduction in concrete due to crack openings.

opening displacement would be very small. As a result, the crack may show little effect on concrete permeability, as measured on unloaded specimens.

**Crack Patterns.** To investigate the crack characteristics, some specimens were examined under an optical microscope with a magnification of 100x. The sequential crack patterns in the specimens with different crack widths are shown in Figure 6. It was noticed that the crack initiated in the center of a specimen where the uniform tensile stress was developed under the splitting load. The crack grew toward the edge of the specimen as the measured crack opening displacement increased. Then, two main branch cracks were observed, and wedges formed due to the confinement of the concrete by the wood-bearing strips at the loading points. With further loading, additional fine cracks appeared and the main cracks jointed together. The increased crack connectivity may have a great contribution to permeability of the concrete. Although the specimen having a measured crack opening displacement of 900 microns did not break apart during the splitting test, it was too fragile to be handled for a permeability test.

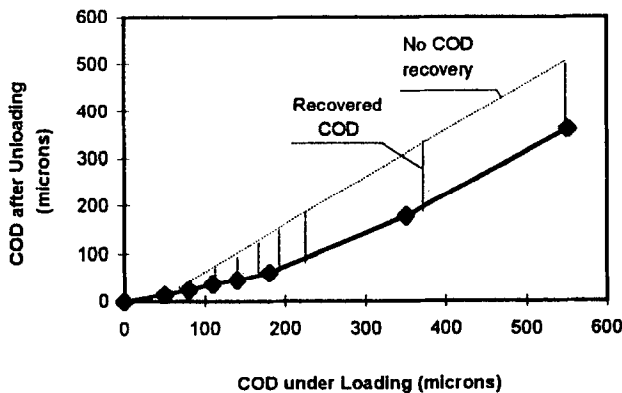

FIG. 5. Recovery of Crack Opening Displacement (COD) after unloading.



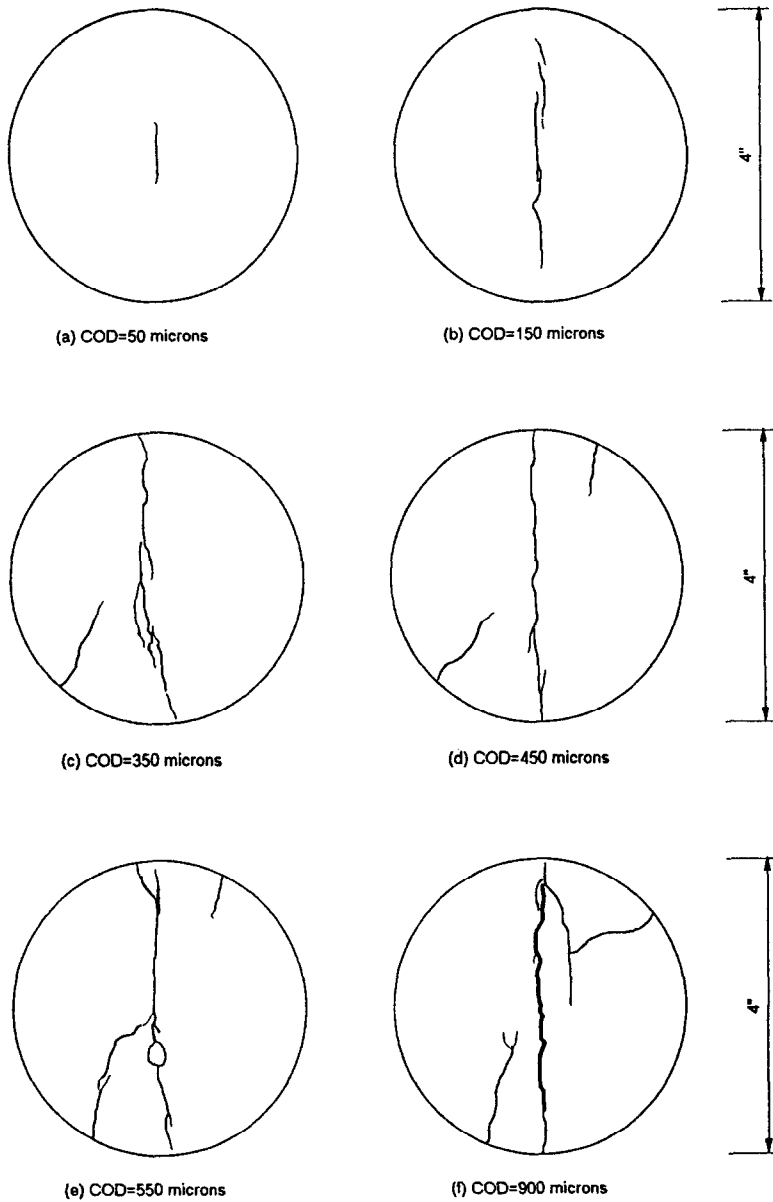

FIG. 6.  
Crack patterns.

The observed sequential crack patterns and measured crack openings provide us with important information on the crack characteristics in the concrete specimens. However, cracks may initiate from the surface of the specimens, and further study is needed to know if or when the cracks go completely through the thickness of a specimen.

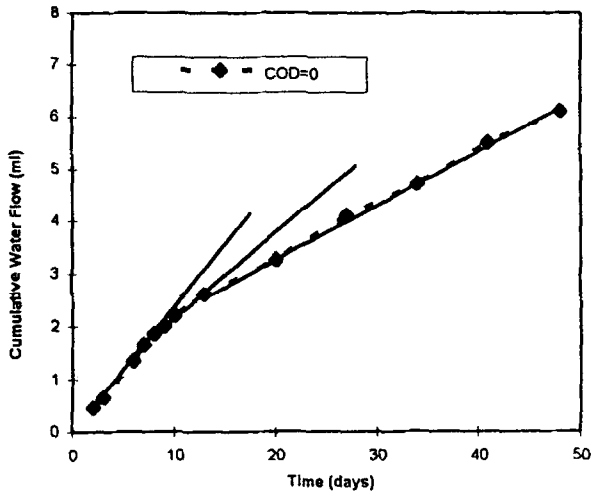

FIG. 7.  
A typical permeation curve.

**Water Permeability Tests.** A typical permeation curve obtained from water permeability tests is shown in Figure 7. The slope of a tangent line at a given point of the curve is directly proportional to the permeability coefficient of the concrete specimen at a given time of testing for a fixed water head. It was observed that at the beginning of the test, the cumulative water flow increased non-linearly with time. After 20 days, water flow became steady and slower. The nonlinearity was likely due to the incomplete saturation of the specimen and unavoidable existence of air bubbles in the specimen, even though special care had been taken. The decreasing flow rate might also be due to the precipitation of some substances from leaching of calcium hydroxide in concrete with time. The substances could block small

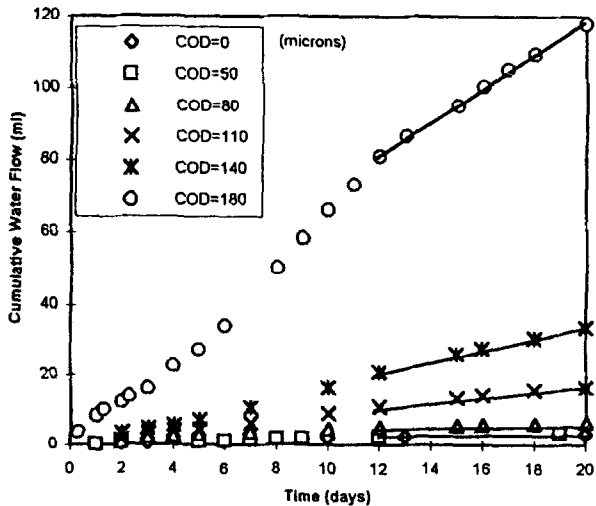

FIG. 8.  
Permeation curves of concrete specimens with different crack widths.

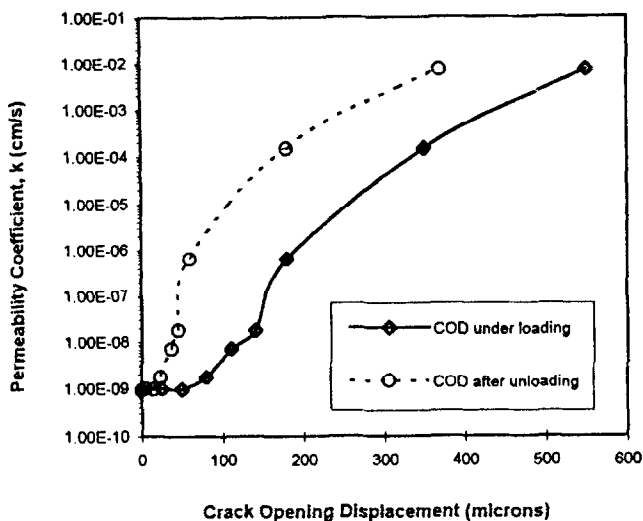

FIG. 9.

Relationship between water permeability and crack widths.

pores on surface of the concrete so as to reduce permeability. Leaching of calcium hydroxide was observed during the curing of the concrete specimens under water. Further research is needed to study the causes of water permeability reducing with time.

Figure 8 shows the permeation curve of the concrete specimens with different cracks openings (prior to unloading). It was observed that for the concrete specimen having a small crack, crack opening displacement equal to or smaller than 50 microns, the flow rates were very low. Therefore, the permeability readings were taken once a day during the first week of testing, then taken once every two days or every seven days during the rest of the testing period so as to minimize the reading errors. For the specimen with a cracking opening displacement of 180 microns, water flow rate was quite high. The reading had to be taken twice a day during the first few days of the test so as to prevent water from dropping below the readable marker on the pipette. The permeability coefficient,  $k$ , of a specimen was calculated using the slope of the best-fitting straight line of the last part of its permeation curve and considering the falling water head in a reading time interval. For specimens with crack opening displacements of 350 and 550 microns, it took less than 2 minutes for water to drop from the top to the bottom of the pipette. Thus, the time of the water drop was recorded with a stopwatch, and the average of five flow rate measurements, which were very all close, was used for permeability coefficient calculations.

Figure 9 presents the relationship between water permeability and crack openings. It was observed that when a specimen had a crack opening displacement less than 50 microns under loading, it showed little effect of the crack opening on concrete permeability. While the crack opening displacement increased from 50 microns to about 200 microns, water permeability increased rapidly. When the crack opening displacement was larger than 200 microns, the rate of increase of water permeability became steady and less rapid.

In addition to crack width, crack length and the number of cracks also influence concrete permeability. Figure 6 shows that the crack length and the number of cracks vary with pre-determined crack opening displacements in the splitting tests. Appropriate methods are

needed to gain accurate measurements of crack length, including microcracks, and the number of cracks in the whole area of the specimens.

Considering concrete deterioration due to cracking, ACI Building Code (ACI 318-89 Commentary, Section 10.6) limits crack widths by limiting the distribution of flexural reinforcement in reinforced concrete design (7). The Code limitations are based on crack widths of 0.016 in. (400  $\mu\text{m}$ ) for interior exposure and 0.013 in. (330  $\mu\text{m}$ ) for exterior exposure, which are arbitrary numerical values based on past experience. According to the present study, the permeability coefficient of concrete is about  $10^{-3} \sim 10^{-2}$  cm/sec when crack openings are about 300  $\sim$  400  $\mu\text{m}$ , compared with  $10^{-10} \sim 10^{-9}$  cm/sec for uncracked concrete. With such high permeability, considerable leaking and subsequent corrosion of reinforcement may occur in the concrete structure during a limited service period. However, the cracks generated by the splitting tests may be the identical in widths on the inside as on the surface of the specimens, while the crack widths adopted by the Code are surface crack widths and actual shear deformation of the concrete cover and curvature of flexural members will result in narrower crack widths at the level of the steel than at the surface, (i.e., V-shaped cracks). Further research is needed to study the effect of crack shape, connectivity and tortuosity on permeability. The present study provides engineers with insight into developing design criteria for a durable concrete and in predicting service life of a concrete structure.

### Summary and Conclusions

- The present research introduces feedback controlled splitting tests as a way to generate width-controlled cracks in concrete specimens. This testing method has several advantages: (1) cracks are produced by tensile stresses, (2) crack opening displacement is recorded during loading and after unloading, and (3) the cylindrical specimens used in the loading tests are preferable for conventional concrete permeability tests.
- In this study, feedback controlled splitting tests were performed to obtain a series of concrete specimens with different crack widths. The results indicate that the crack opening displacement at the peak stress is less than 20 microns. At this loading level, about 80% of the displacement is recovered after unloading, and the remaining crack opening is very small, which may show little effect of cracking on concrete permeability.
- Water permeability of concrete with different crack widths was evaluated. The results indicated that concrete permeability increased with crack width. The degree of the permeability increase depended on the value of the crack opening in the concrete. When a crack opening displacement was small, less than 50 microns under loading, the crack opening had little effect on concrete permeability. With the crack opening displacement increasing, from 50 to 200 microns, concrete permeability increased rapidly. When the crack opening displacement was large, beyond 200 microns, the rate of increase of water permeability became steady and less rapid.

### Acknowledgments

This research is supported by NSF grant DMS9313013 to the National Institute of Statistical Sciences. Support from the NSF Center for Science and Technology of Advanced Cement Based Materials (ACBM) is also appreciated.

### References

1. Concrete Technology, Past, Present, and Future, Proc. of V. Mohan Malhotra Symposium, ed. by P.K. Mehta, ACI SP-144, 1-30, (1994).
2. M. Saito, *Cem. and Concr. Res.* 25, (4), 803 (1995).
3. D. Ludirdja, R.L. Berger, and J.F. Young, *ACI Mat. J.* 86, (5), 433 (1989).
4. M. Tsukamoto, *Darmstadt Concrete, Annual J. on Concr. and Concr. Str.* 7, 215 (1992).
5. J.N. Cernica, *Geotechnical Engineering: Soil Mechanics*, John Wiley & Sons, 125 (1995).
6. R. Gettu, B. Mobasher, S. Carmona, and D. Jansen, *Adv. Cem. Based Mat.* 3, (2) 54 (1996).
7. ACI Committee 318, "Building Code Requirement for Reinforced Concrete (ACI 318-89)", Am. Concr. Inst., Detroit, 106-108 (1989).